

INSTALLATION MANUAL

VOXORT

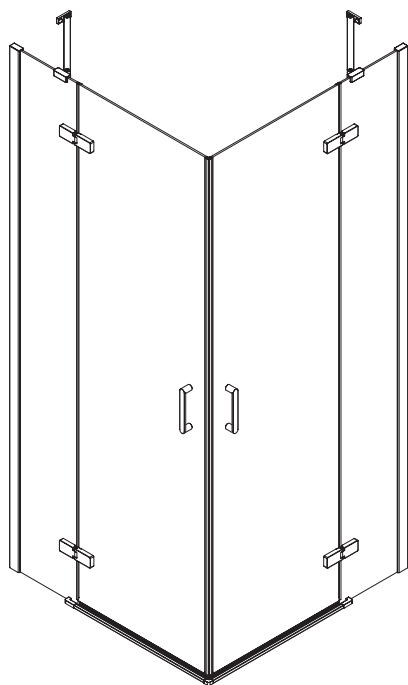

HR Upute za montažu,
čišćenje i održavanje



Upozorenje

Prije ugradnje provjerite ugradne mjere budući da se one uvijek razlikuju od nazivnih. Apsolutno brtvljenje tuš kabina i/ili vrata/stranica nije moguće. Srednja vodonepropusnost. Molimo Vas da se upoznate sa uputama prije početka montaže:

1. Provjerite da li imate potreban alat
 2. Provjerite da je mjesto za montažu kompatibilno sa veličinom kupljenih vrata
 3. Provjerite sve priložene komponente
 4. Provjerite da je oprema za montažu kompletna
- NE POČINJITE montažu ako niste provjerili sve 4 točke iznad

Osigurajte da ispod navedena 3 artikla nisu problem prije bušenja rupa na zidu.

1. Zidne uloške dobivene od proizvođača unutar opreme za montažu namijenjene su za upotrebu na čvrstim zidovima. Šuplji ili montažni zidovi zahtijevati će alternativne uloške.
2. Osigurajte da nema vodiča, cijevi ili drugih stvari skrivenih unutar zida.
3. Možda će biti potrebno kontaktirati dobavljača pločica vezano uz pravilnu metodu bušenja pločica.

Staklo je lomljivo, molimo obratiti posebnu pozornost pri pomicanju ili montaži i izbjegavajte udarce u tvrde površine. Stavite ih u pravilan položaj, malo ukoso na zid na meku podlogu nakon raspakiranja.



U slučaju nedostatka ili oštećenja nekih dijelova potrebno je isto prijaviti dobavljaču unutar 8 dana od dana kupnje. Pregledati tuš kabinu prije montaže. Nikakve pritužbe neće biti prihvaćene nakon što je proizvod instaliran.

EN
Warning

Before final montage please note and check that final Installation measure don't suit measure in name. Absolute sealing for all doors, side panels and shower enclosure is not possible. Medium water resistance. Please familiarise yourself with the fitting instructions before commencing fitting.

1. Check that you have the tools required.
2. Check that the installation site is compatible with size of door supplied.
3. Check all the enclosure components.
4. Check that the installation kit is complete.

DO NOT attempt to install the product unless you can tick all 4 boxes as satisfactory.

Ensure the below 3 items are no problem before drilling holes on wall.

1. The wall plugs supplied with the installation kit are for use in solid walls. Hollow or 'stud-partition' walls will require alternative fixings.
2. Please consult a hard ware supplier for the correct type.
3. Ensure there is no wire, pipe and any other things hidden in wall.

It may also be necessary to consult your tiling supplier about the correct method for drilling your ties.

Glass is fragile, please pay great care when you move or install it and avoid bumping it into hard things. Place them upright but slightly aslant against the wall on the soft cushion after unpack it

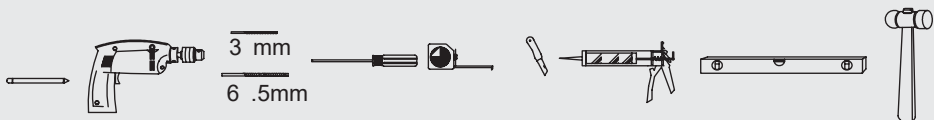







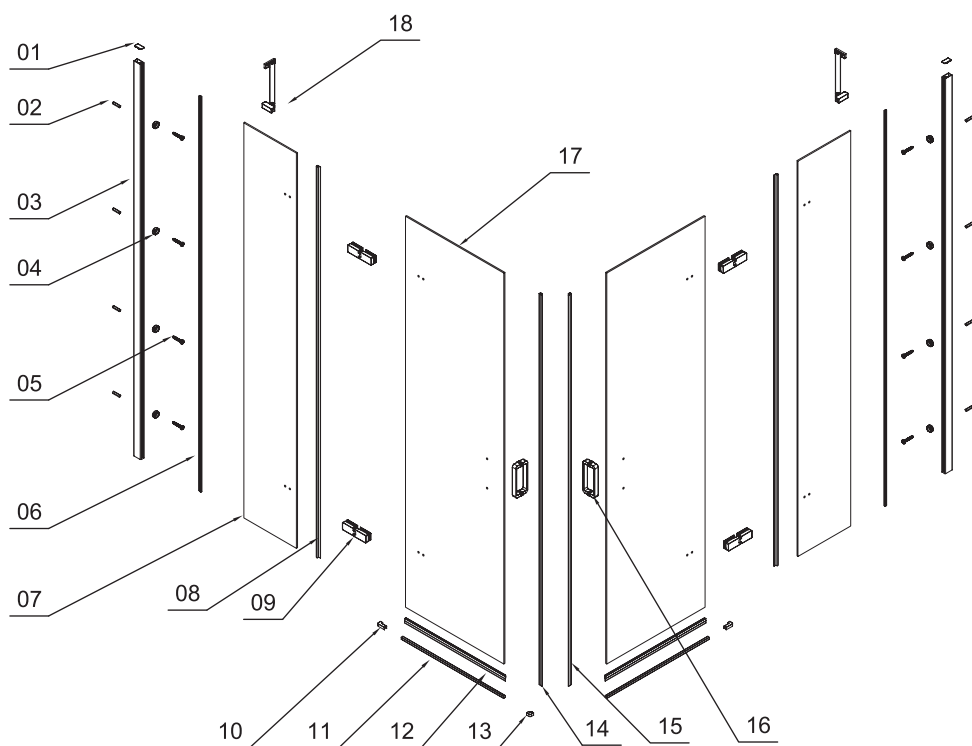



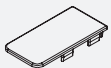



Any parts missing or damaged must be reported to your supplier within 3 days of purchase. Inspect shower enclosure before fitting. No claims will be acceptable after product has been installed.







VOXORT

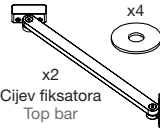

and water is so amazing







Popis dijelova / Parts supplied:



1	 LP-1354	2x	7	Fiksno staklo Fixed panel	2x	13	 Završna kapa End cap	1x
2	 Zidni uložak Wall plug	12x	8	 Brtva stranice Water seal	2x	14	 Magnetna brtva (A) Magnetic seal (A)	1x
3	 Zidni profil Wall channel	2x	9	 Panti Hinge	4x	15	 Magnetna brtva (B) Magnetic seal (B)	1x
4	 Podloška vijka Screw washer	8x	10	 Lx1 Rx1 završne kape Lx1 Rx1 end cap	2x	16	 Ručka Handle	2x
5	 ST4*30 B vijak ST4*30 B head screw	12x	11	 Prag Bottom strip	2x	17	Tuš vrata Door	2x
6	 Brtva Tight seal	2x	12	 Brtva Bottom seal	2x	18	 Cijev fiksatora Top bar	2x

 x2 Cijev fiksatora Top bar	 x4 Ukрасne kapice za staklo Glass clip cap	 x4 M6x16 vijak za imbus M6x16 hex screw	 x4 ST4x30 B vijak ST4x30 B head screw
 x4 M8x6 vijak M8x6 grub screw	 x4 Ø6x30 zidni uložak Ø6x30 wall plug		

 x4 Panti Hinge	 x2 Ručka Handle
--	---

 x8 Podloška vijka Screw washer	 x8 ST4*30 B vijak ST4*30 B head screw	 x8 Ø6x30 wall plug Ø6x30 zidni uložak	 x2 Podložak Spacer
--	---	---	---

 x1 Završne kape End caps	 x1	 x1
--	--	--

 x1 4 mm imbus 4 mm hex spanner	 x2 LP-1354	 x8 LP-1884
--	---	---

VAŽNO

1. Osigurati da gornji rub tuš kade na koju će se instalirati bude niveliran u svim smjerovima
2. Pločice ili druge zidne obloge moraju biti zabrtvljene sa rubom kade
3. Pločice je potrebno produžiti od ruba tuš kade i minimalno 2,1m prema gore

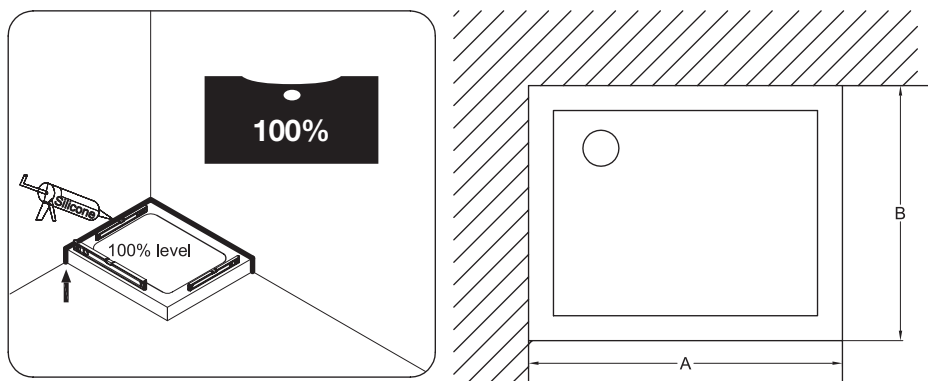

Molimo vas da izmjerite udaljenost između dva zida prije instalacije. Potvrdite da je udaljenost unutar preporučenih vrijednosti za montažu proizvoda.

Raspon ugradnje:		
Proizvod:	A (mm)	B (mm)
900 vrata	875-895	875-895
1000 vrata	975-995	975-995
1100 vrata	1075-1095	1075-1095
1200 vrata	1175-1195	1175-1195

IMPORTANT

1. Ensure the top surface of the shower tray on which the enclosure will be installed is level in every direction.
2. The tiles or other wall finishing should be effectively sealed at tray edges.
3. Tiles should extend at least to the corner of the tray and a minimum of 2.1 meters from top of the tray.

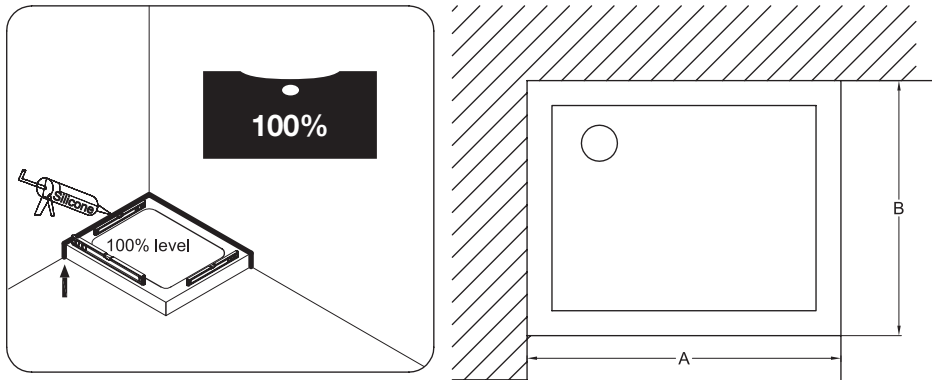

Please measure distance between two walls before installation. Ensure the distance is within the distance is within the adjustment range of the product, as is listed left.

Adjustment range:		
Product:	A (mm)	B (mm)
900 hinge door	875-895	875-895
1000 hinge door	975-995	975-995
1100 hinge door	1075-1095	1075-1095
1200 hinge door	1175-1195	1175-1195

VOXORT

and water is so amazing

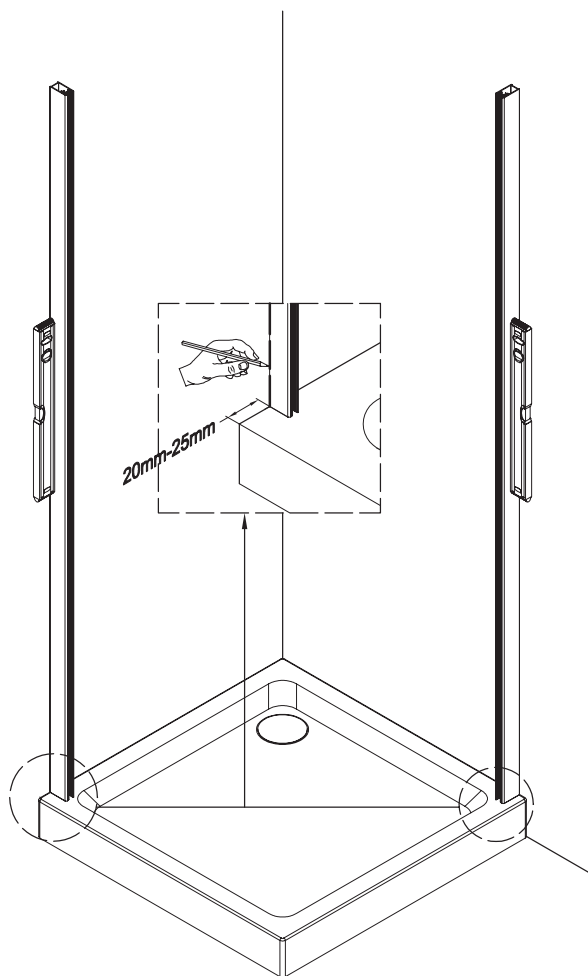
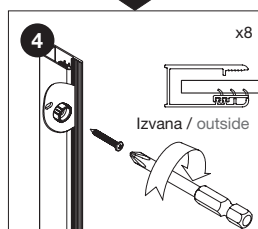
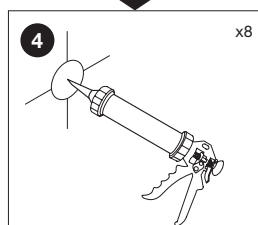
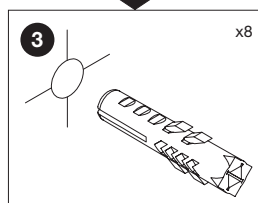
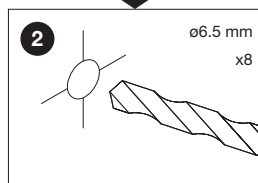
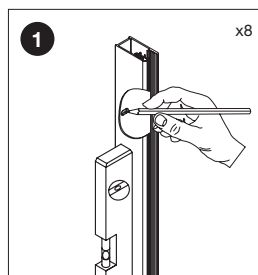

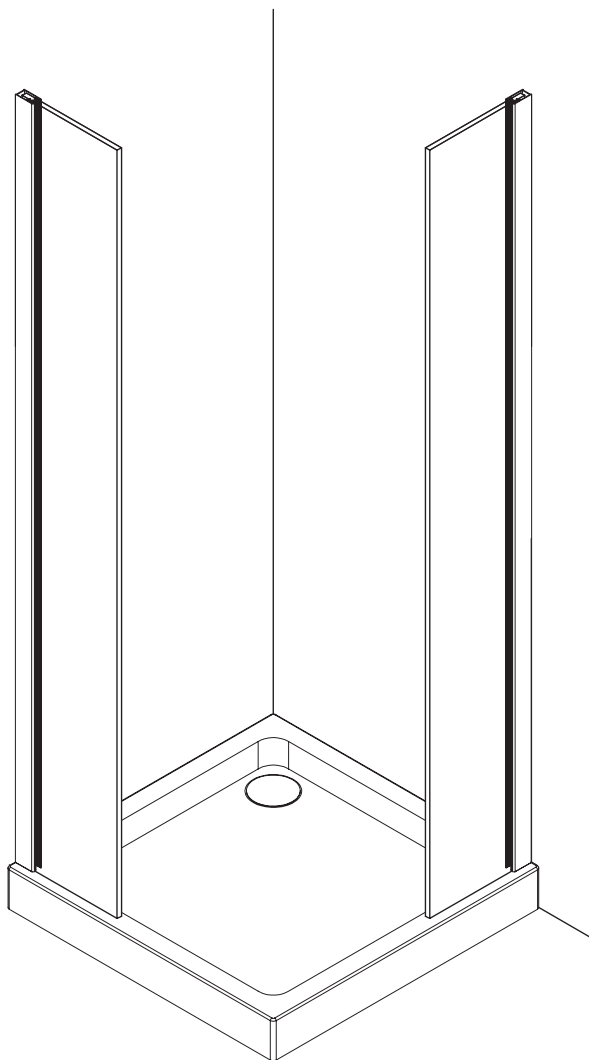
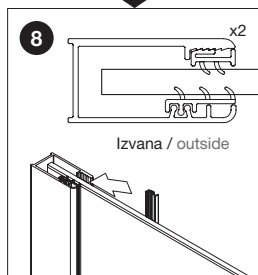
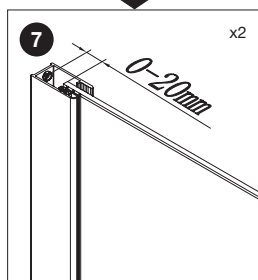
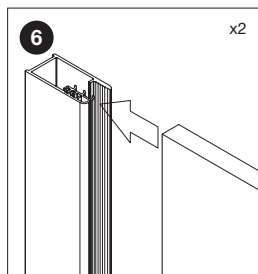

VOXORT

and water is so amazing

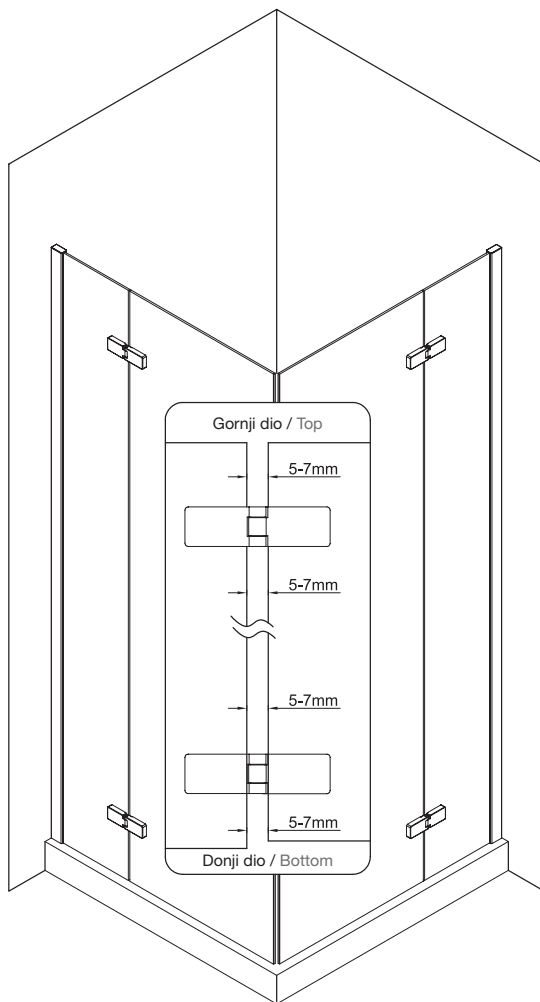
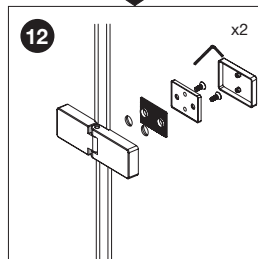
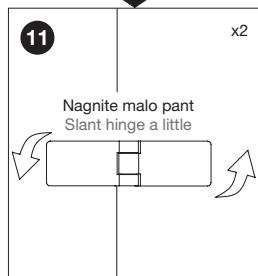
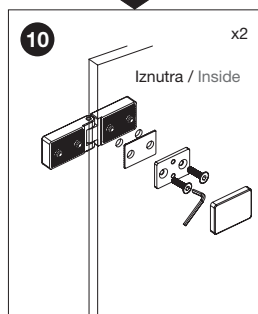
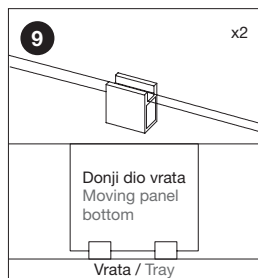

VAŽNO / IMPORTANT

20mm	20mm	Vrata / Door	20mm
↓	↓		↓
↑	↑	Tuškada / Tray	↑

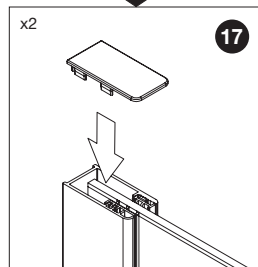
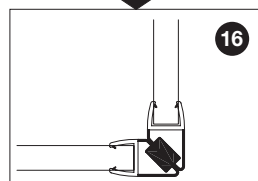
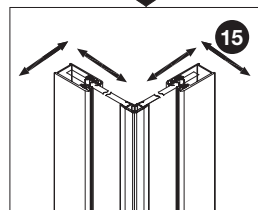
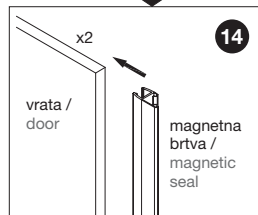
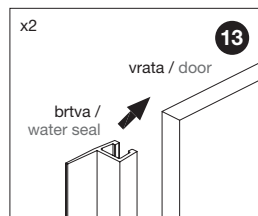
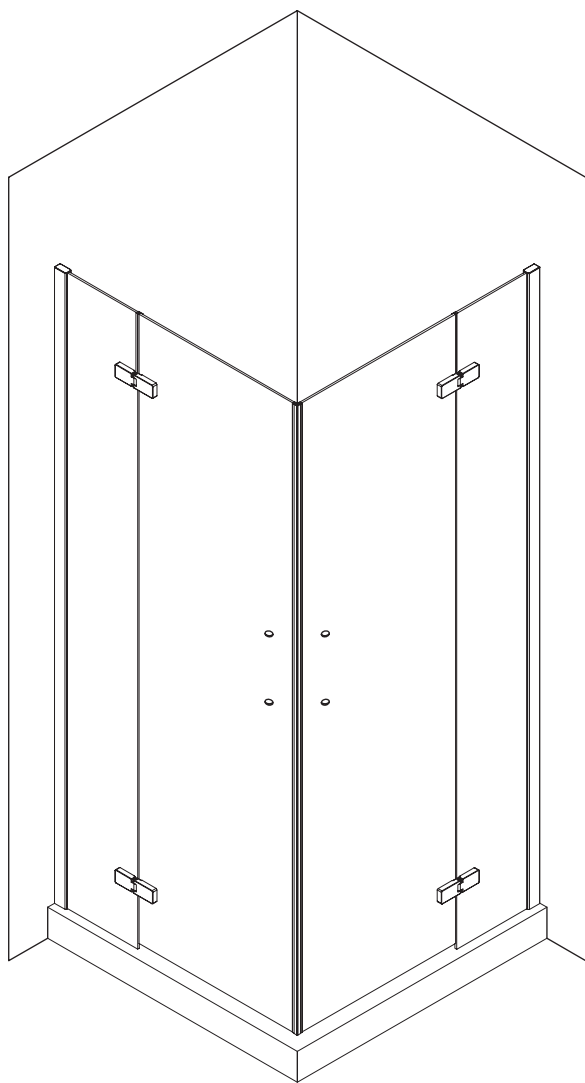

VOXORT

and water is so amazing

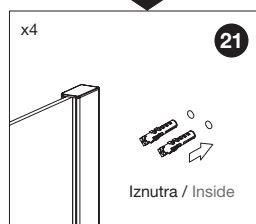
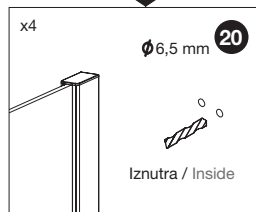
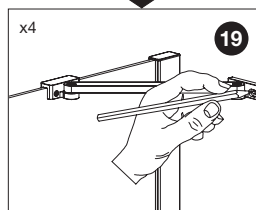
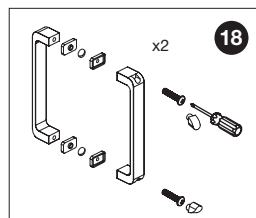
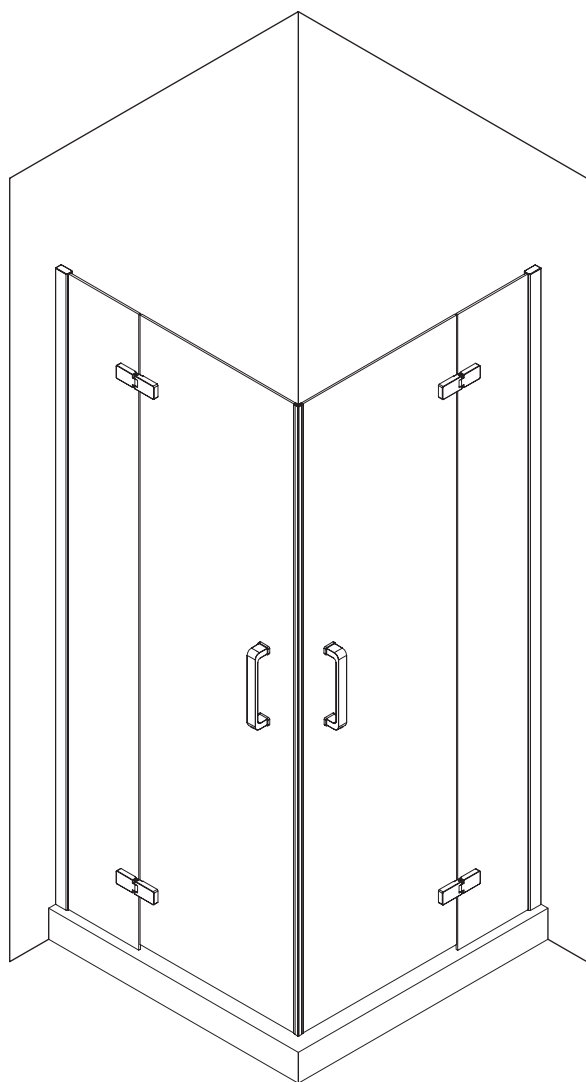

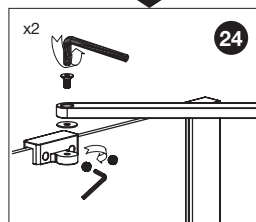
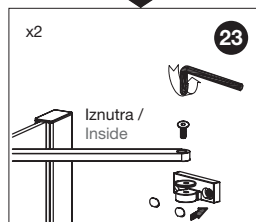
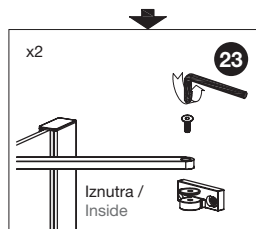
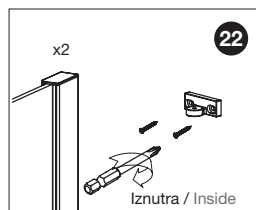
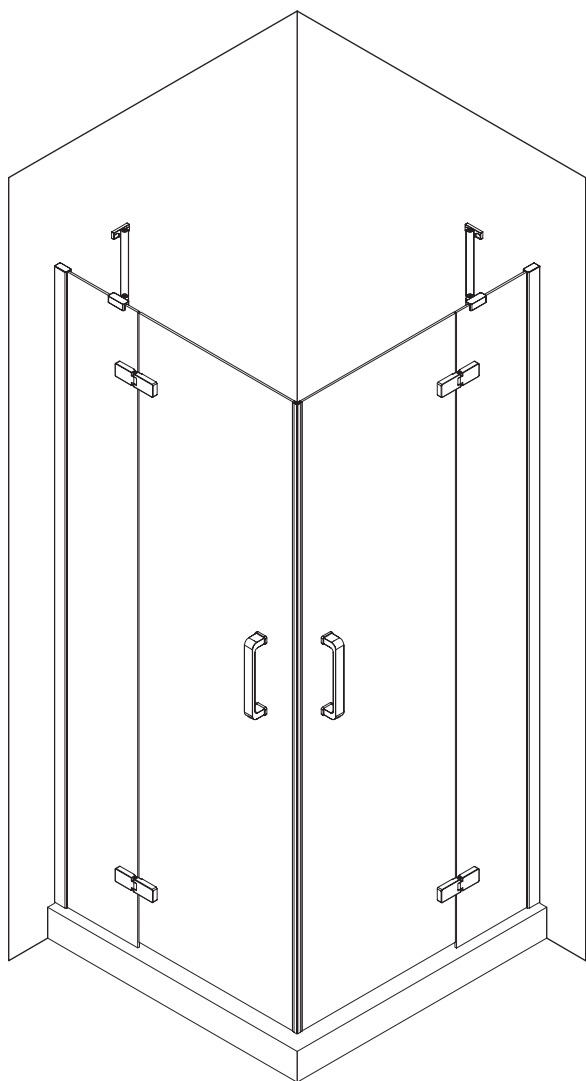

Čišćenje i održavanje / Cleaning and maintenance

Održavajte i čistite svoju kabinu redovito kako bi spriječili nastanak kamenca i problema prilikom zatvaranja. Čišćenje tuš kabine vršite s mekom krpom i blagim deterdžentom. Kabinu ne čistite s agresivnim sredstvima kao što su alkohol, benzin ili ostala kemijska sredstva. Nakon što je kabina postavljena ukoliko prilikom otvaranja/zatvaranja vrata škripe možete sredstvo za podmazivanje staviti na valjak kotača, profil.

Maintain and clean your cabin regularly to prevent limescale and closing problems. Clean the shower enclosure with a soft cloth and a mild detergent. Do not clean the cabin with aggressive agents such as alcohol, petrol or other chemicals. If the doors are creaking after the cabin is installed, you can put lubricant on the wheel roller, profile.