

Concepto

V453288

EN Installation instruction DE Montageanleitung SL Navodila za namestitev HR Upute za montažu

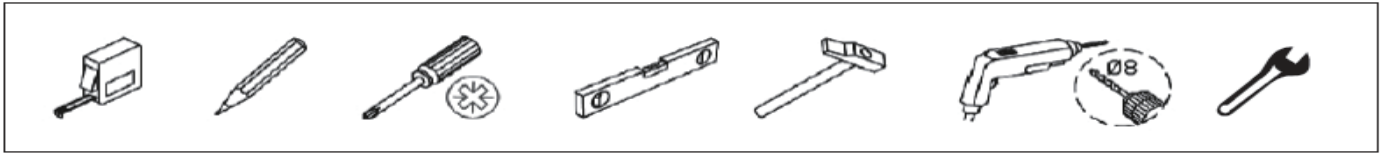

1. According to the different mirror structure, there are 3 different hanging systems.

Entsprechend der unterschiedlichen Spiegelstruktur gibt es 3 verschiedene Aufhängesysteme
Prema različitoj strukturi ogledala, postoje 3 različite opcije montaže.

Glede na različno strukturo zrcala obstajajo tri različne možnosti pritrditve.

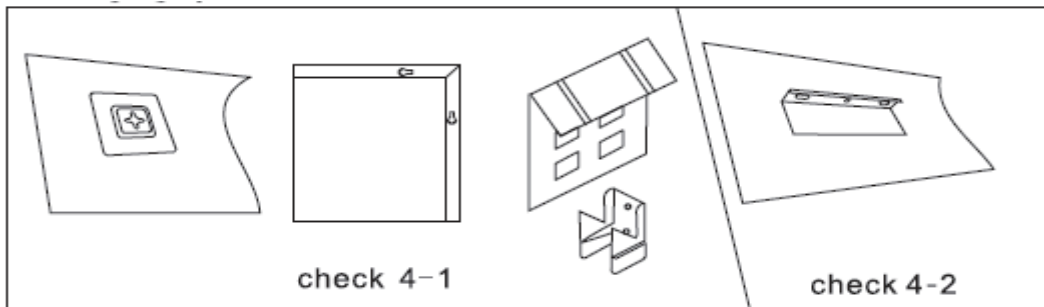

2. Measure the distance between two brackets, install the expansion bolt and screw on the wall.

Messen Sie den Abstand zwischen zwei Halterungen, installieren Sie den Spreizdübel und schrauben Sie ihn an der Wand fest.

Izmjerite potrebnu udaljenost između dva nosača, postavite zidni uložak i vijak te pričvrstite na zid.
Izmerite razdaljo med dvema nosilcem, vstavite ekspanzijski vijak in ga pritrdite na steno.

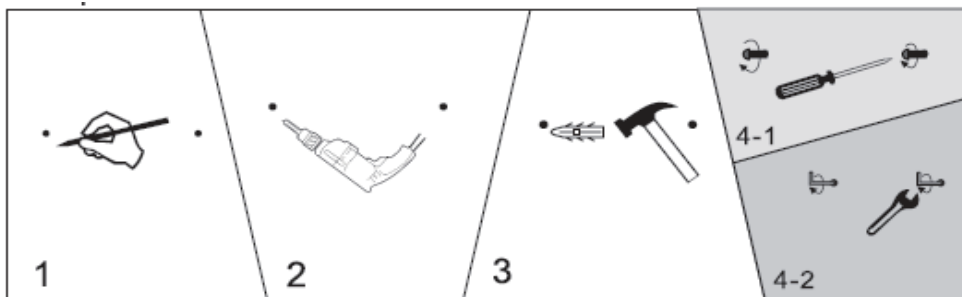

3. Open the cover by screwdriver, install the main power, seal the cover, than hang the mirror on the wall.

Öffnen Sie die Abdeckung mit einem Schraubendreher, schließen Sie die Hauptstromversorgung an, verschließen Sie die Abdeckung und hängen Sie den Spiegel dann an die Wand

Otvorite poklopac odvijačem, postavite glavno napajanje, vratite poklopac te postavite na zid.

Odprite pokrov z izvijačem, namestite glavno napajanje, zapečatite pokrov, nato obrnite ogledalo na steno.

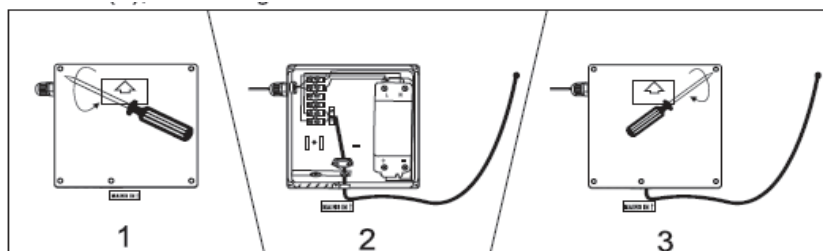

Fero-Term d.o.o.
Gospodarska 17,
10255 D.Stupnik, HR
Tel.+385 1 4555 535
info@fero-term.hr

Fero-Term - Slovenia
Kajuhova 32T
10000 Ljubljana, SLO
info@fero-term.si

Servis:
Fero-Term d.o.o.
Gospodarska 17,
10255 D. Stupnik, HR
01/ 4555 535
servis@fero-term.hr

Technical data sheet

RAFI

Mirror with LED lighting Concepto+ Rafi Touch, 80x5x80 cm

Spiegel mit LED-Beleuchtung Concepto+ Rafi Touch, 80x5x80 cm

Ogledalo z LED osvetlitvijo Concepto+ Rafi Touch, 80x5x80 cm

Ogledalo sa LED rasvjetom Concepto+ Rafi Touch, 80x5x80 cm

Order No: **V453288**

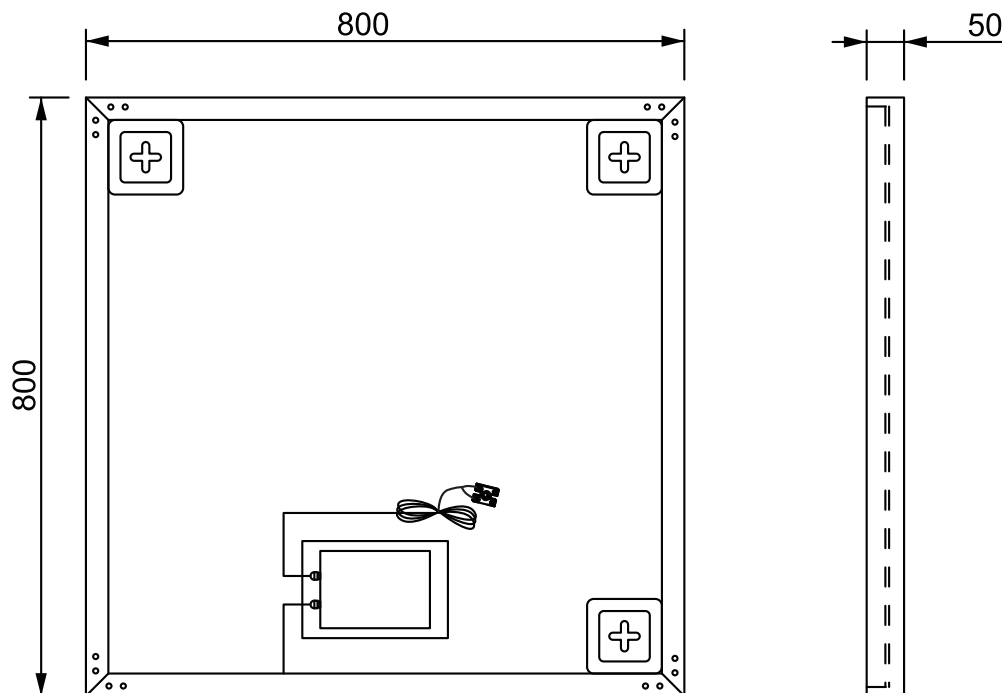
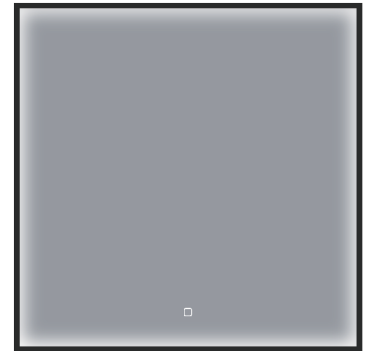

TECHNICAL DATA / TEHNIČKI LIST		
Order no. / Šifra	V453288	SPECIFICATION TEXT Mirror with light, 5mm copper free silver mirror, integrated in aluminium frame electro polished, LED light inside aluminium alloy, 1x 20.8 W, 6000 Kelvin (daylight), IP44, 230V SPECIFIKACIJA Ogledalo 5mm sa rasvjetom, ogledalo i LED svjetlo integrirano u elektro polirani aluminijski okvir 1x 20.8 W, 6000 Kelvin (dnevno svjetlo), IP44, 230V
Certified to / Certificirano	IP44, 60598-2-1, 60598-1, 62493, 62471	
Dimensions / dimenzije	800x800x50 mm	
Weight / Težina	kgs	
Switch / prekidač	Touch	
Mounting accessories / montažni prigobr	Included / uključen	

Fero-Term d.o.o.
Gospodarska 17,
10255 D.Stupnik, HR
Tel.+385 1 4555 535
info@fero-term.hr

Fero-Term - Slovenia
Kajuhova 32T
10000 Ljubljana, SLO
info@fero-term.si

Servis:
Fero-Term d.o.o.
Gospodarska 17,
10255 D. Stupnik, HR
01/ 4555 535
servis@fero-term.hr