

Informacijski list

viega



Prestabo-Koljeno 45° sa SC-Contur

- press priključci

Oprema

Brtni elementi EPDM

Model 1126

Artikl 558 314

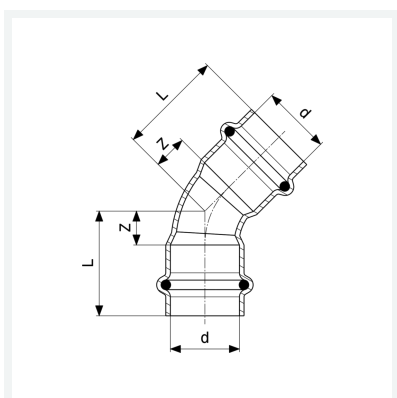

Svojstva

VdS-dopuštenje	VdS	✓
Vanjski promjer cijevi	d	42
Z-dimenzija	Z	21 mm
Duljina	L	57 mm
Z-dimenzija (prethodna verzija)	Z*	33 mm
Duljina (prethodna verzija)	L*	69 mm
Težina	235 g	
Volumen	828,8 cm ³	
Materijal	nelegirani pocinčani čelik	