

Concepto

Installation instruction / Upute za montažu / Navodila za montažu

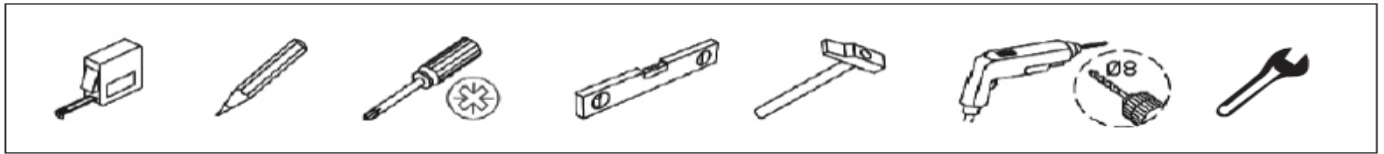

1. According to the different mirror structure, there are 3 different hanging systems.

Prema različitoj strukturi ogledala, postoje 3 različite opcije montaže.

Glede na različno strukturu zrcala obstajajo tri različne možnosti pritrditve.

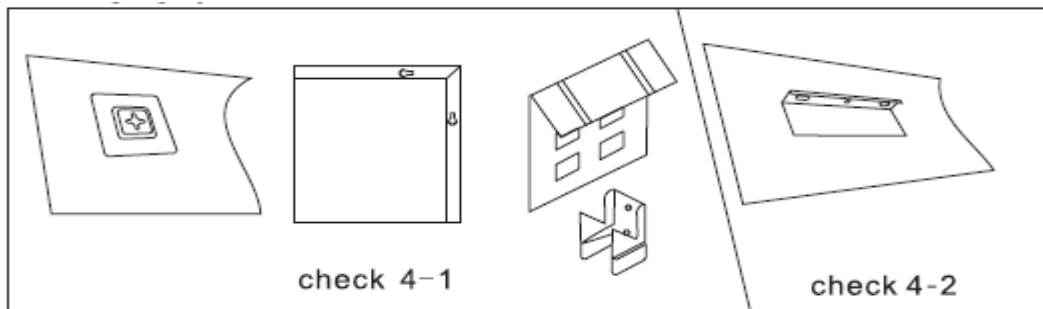

2. Measure the distance between two brackets, install the expansion bolt and screw on the wall.

Izmjerite potrebnu udaljenost između dva nosača, postavite zidni uložak i vijak te pričvrstite na zid.

Izmerite razdaljo med dvema nosilcem, vstavite ekspanzijski vijak in ga pritrdite na steno.

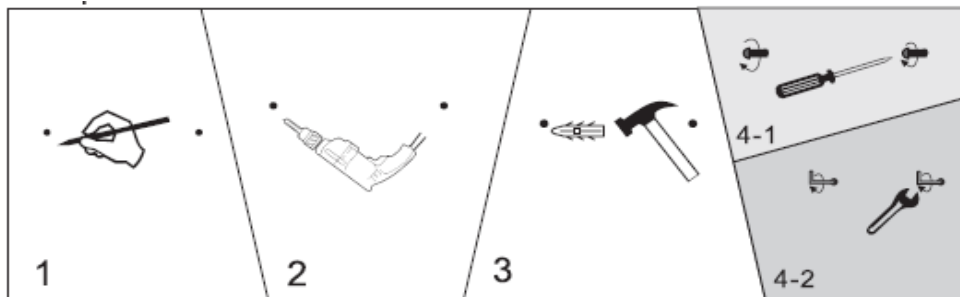

3. Open the cover by screwdriver, install the main power, seal the cover, than hang the mirror on the wall.

Otvorite poklopac odvijačem, postavite glavno napajanje, vratite poklopac te postavite na zid.

Odprite pokrov z izvijačem, namestite glavno napajanje, zapečatite pokrov, nato obrnite ogledalo na steno.

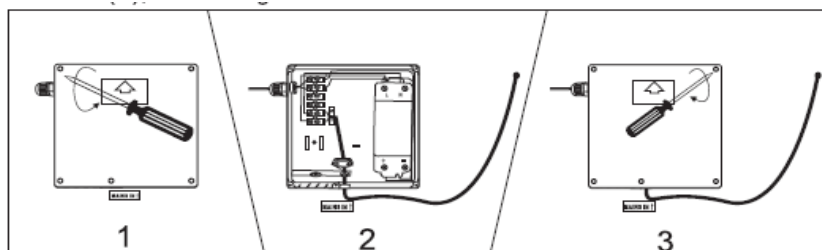

Technical data sheet

ESTHER

CONCEPTO+ LED MIRROR ESTHER 80x3x60 TOUCH

CONCEPTO+ OGLEDALO S RASV. LED ESTHER 80x3x60 TOUCH

Order No: N15779

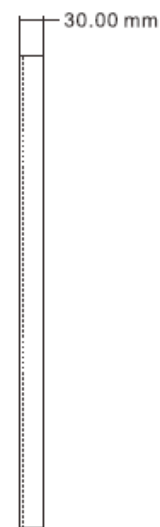
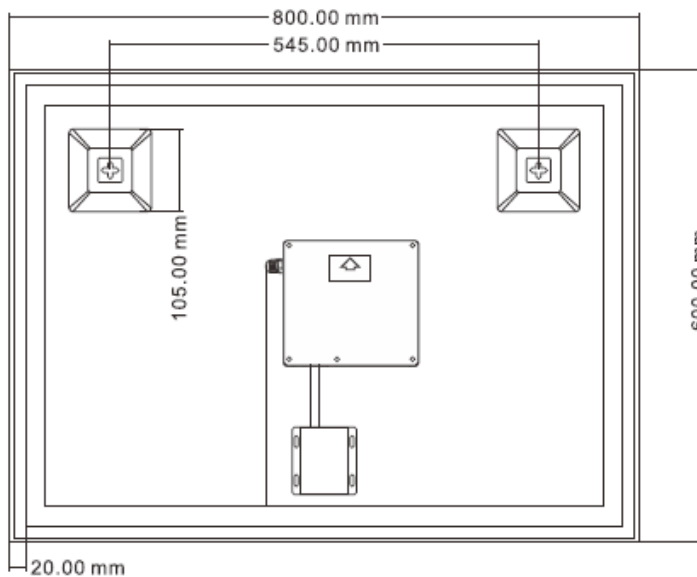
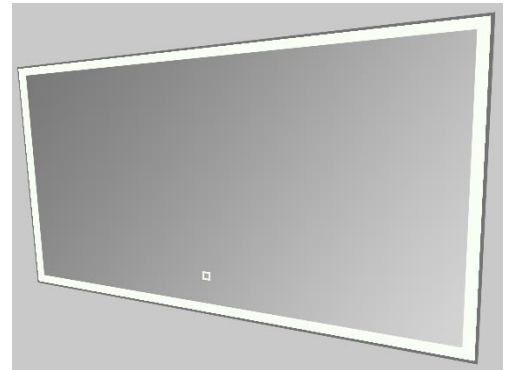

TECHNICAL DATA / TEHNIČKI LIST		
Order no. / Šifra	N15779	SPECIFICATION TEXT Mirror with light, 5mm copper free silver mirror, integrated in aluminium frame electro polished, LED light inside aluminium alloy, 1x 15W, 6500 Kelvin (daylight), IP44, 230V SPECIFIKACIJA Ogledalo 5mm sa rasvetom, ogledalo i LED svjetlo integrirano u elektro polirani aluminijski okvir 1x 15W, 6500 Kelvin (dnevno svjetlo), IP44, 230V
Certified to / Certificirano	IP44, 60598-2-1, 60598-1, 62493, 62471	
Dimensions / dimenzije	800x600x30 mm	
Weight / Težina	5 kg	
Switch / prekidač	Touch	
Mounting accessories / montažni prigobr	Included / uključen	

Fero-Term d.o.o.
 Gospodarska 17,
 10255 D. Stupnik, HR
 Tel.+385 1 434 3116
info@fero-term.hr

Fero-Term - Slovenia
 Kajuhova 32T
 10000 Ljubljana, SLO
info@fero-term.si

Servis:
 Ferro-Term d.o.o.
 Gospodarska 17,
 10255 D. Stupnik, HR
 01/ 434-3116
servis@fero-term.hr