

**N13464 CONCEPTO+ LAMPA NEW LINEA 400mm**

\*Please read these instruction carefully before starting installation. All fittings must be installed by a competent person.

\*Bitte lesen Sie die Anweisungen sorgfältig durch, bevor Sie die Installation starten. Die Installation muss von qualifiziertem Personal durchgeführt werden.

\*Molimo da se upute pažljivo pročitaju prije početka montaže. Montažu mora vršiti stručna osoba.

CE RoHS   IP44

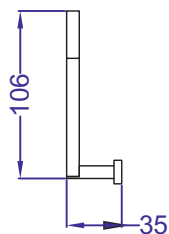
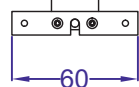
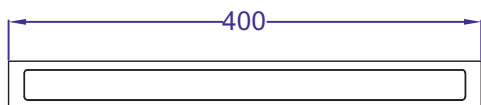
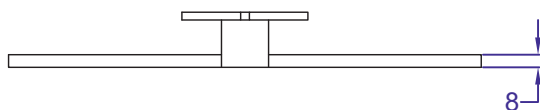
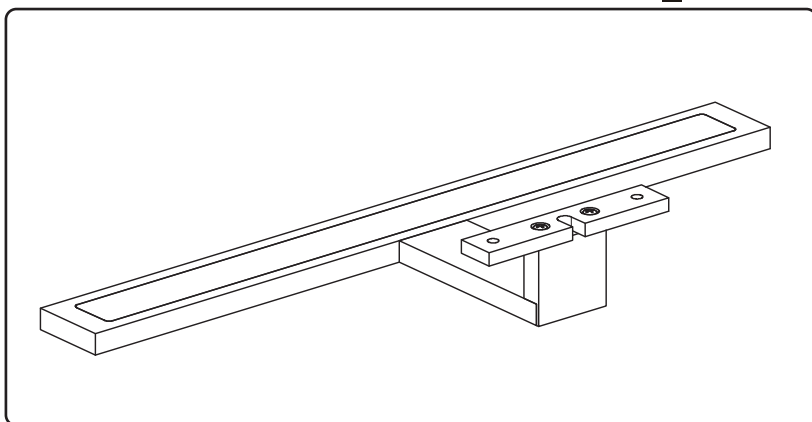
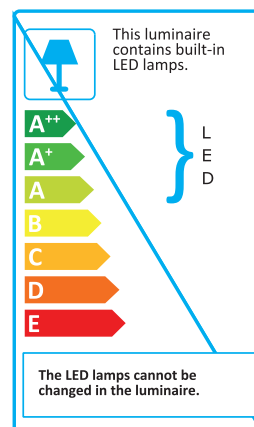
**Product specification/Produktbeschreibung/Specifikacija proizvoda:**

LED	SMD2835*36PCS
Dimension/Dimension/Dimenzija	400*110*35mm
Input/Spannug/Napon	AC100-240V
CCT	4000K
Ra	> 80
Power/Leistung/Snaga	6W
Material/Material/Materijal	AL+ABS+Acrylic/Acryl/Akril
Lumen	350-400LM

\*The lamp contains a LED light bulb. Lamp can be used on bathroom mirror, cabinet top, shelf, over picture and other places. The lamp emits light neutral white, 4000K. The lamp is IP44, which means protection against dust and water. The lamp is simple design in elegant shape, simple installation and easy maintenance.

\* Die Lampe enthält eine LED-Glühlampe. Lampe kann auf Badezimmerspiegel verwendet werden, Schrank oder, Regal, über Bilder und an anderen Orten. Die Lampe emittiert Licht neutral weines, 4000K. Die Leuchte ist IP44, Schutz gegen Staub und Wasser. Die Lampe ist einfach im design und in eleganteform, einfache Installation und Wartung.

\*Lampa sadrži LED žarulju. Lampa se može montirati i koristiti na ogledalu u kupaoni, vrhu ormarića, police, nad slikom i sl. Lampa emitira svjetlost neutralno bijelo, 4000K. Lampa je razreda IP44, što označava zaštitu od prašine i vode. Lampa je jednostavnog dizajna, i elegantnog oblika, jednostavna za instalaciju i za održavanje.

**IP 44**



Tiny size. Super brightness. Ultra-low power consumption. 80% energy saving than the traditional light source. Long lifespan. High brightness. Low heat dissipation. Cold light emitting technology. Eco-Friendliness. No mercury pollution. Being recyclable. No UV and IR radiation. Sturdiness and excellent durability.

**N13464 CONCEPTO+ LAMPA NEW LINEA 400mm**

**Installation/Installation/montaža:**

1. Fasten the bracket of the lamp to the mirror/cabinet/wall.  
Befestigen Sie die Halterung der Lampe auf den Spiegel / Schrank / Wand  
Postaviti nosač svjetiljke za ogledalo / kućište / zid.
2. Install the driver according the drawings  
Installieren Sie den Transformator gemäss den Zeichnungen  
Montirajte transformator prema uputama

1. Fasten the bracket/  
Befestigen Sie die Halterung der Lampe/  
Postavite nosač

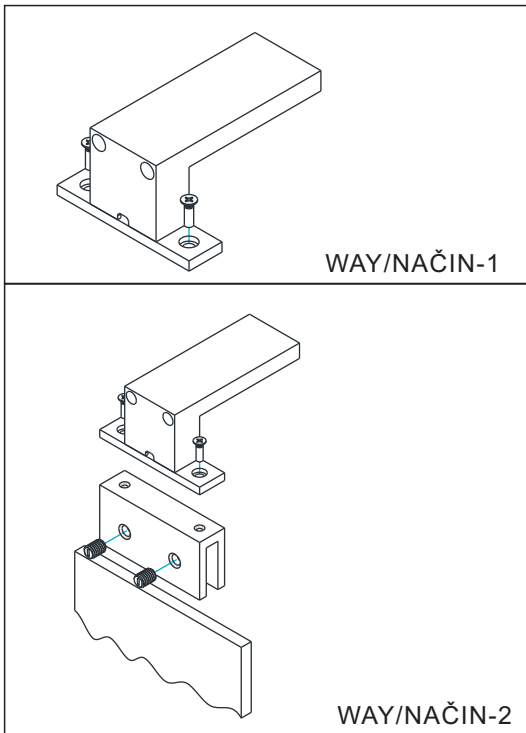

**Faulty and Solution/Fehler und Lösung/Greške i rješenja**

Faults/Fehlerhafte/Greške	Reasons/Gründe/Razlozi	Solutions/Lösungen/Riješenja
There is no lights Kein Licht Svjetlo ne radi	The power is shut off Der Strom ist abgeschaltet Lampa nije upaljena	Turn on the power Schalten Sie das Gerät ein Uključite napajanje
	The connection of power to wire is incorrect Die Verbindung von Draht ist falsch Neispravan je priključak za struju	Change to the right wire Vobinden Sie die Stromdrähte richtig Spojite ispravno žice
There is a flash and then lights off Es gibt einen Blitz und dann Licht aus Lampa bljeska i onda se ugasi	The connection of the cable on lamp to driver becomes loose Der Anschluß des Kabels an Lampentreiber ist gelockert Olabavio se spoj napojnog kabla i lampe	Open the driver and fix it Öffnen Sie den Treiber und befestigen Sie das kabel Otvorite driver i učvrstite

**2. Install the driver/Installieren Sie den Transformator/Montirajte transformator**

