



**Prestabo-Koljeno 90°
sa SC-Contur**

- utični završni komad, press priključak

Oprema

Brtni element EPDM

Model 1116.1

Artikl 558 208

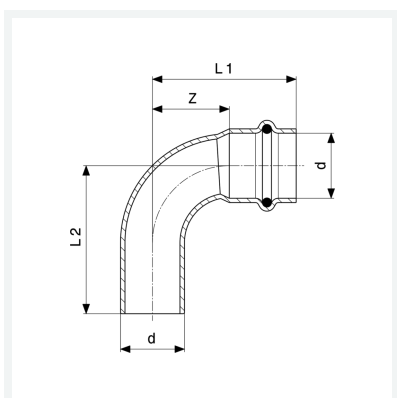

Svojstva

Vanjski promjer cijevi	d	18
Z-dimenzija	Z	18 mm
Duljina 1	L1	40 mm
Duljina 2	L2	42 mm
Z-dimenzija (prethodna verzija)	Z*	30 mm
Duljina (prethodna verzija) 1	L1*	52 mm
Duljina (prethodna verzija) 2	L2*	63 mm
Težina	46,7 g	
Volumen	82,88 cm ³	
Materijal	nelegirani pocinčani čelik	