

Informacijski list

viega



Prestabo-Spojnic sa SC-Contur

- press priključci

Oprema

Brtni elementi EPDM

Model 1115

Artikl 558 000

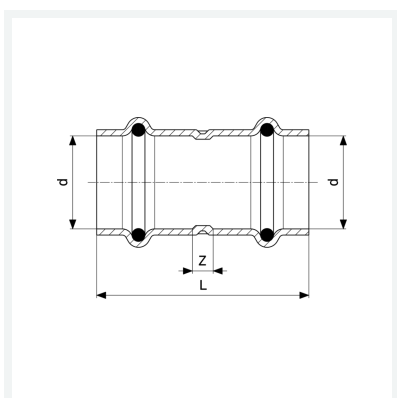

Svojstva

VdS-dopuštenje	VdS	✓
Vanjski promjer cijevi	d	22
Z-dimenzija	Z	12 mm
Duljina	L	58 mm
Težina	57,4 g	
Volumen	82,88 cm ³	
Materijal	nelegirani pocinčani čelik	