



**Prestabo-Koljeno 90°  
sa SC-Contur**

- press priključci

**Oprema**

Brtni elementi EPDM

**Model 1116**

**Artikl 558 147**

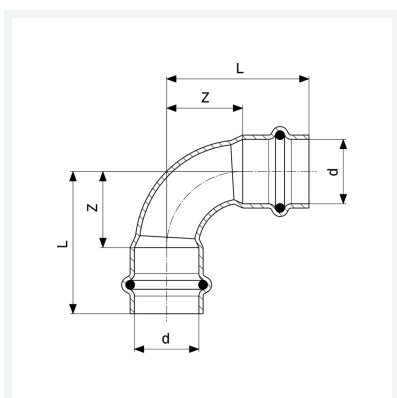

## Svojstva

VdS-dopuštenje	VdS	✓
Vanjski promjer cijevi	d	22
Z-dimenzija	Z	26 mm
Duljina	L	49 mm
Z-dimenzija (prethodna verzija)	Z*	44 mm
Duljina (prethodna verzija)	L*	67 mm
Težina	76 g	
Volumen	155,4 cm <sup>3</sup>	
Materijal	nelegirani pocinčani čelik	