

Data sheet



Adapter

- soldered connection, R-thread

Note

WRAS approved product

Model 94243G

Article 101 749

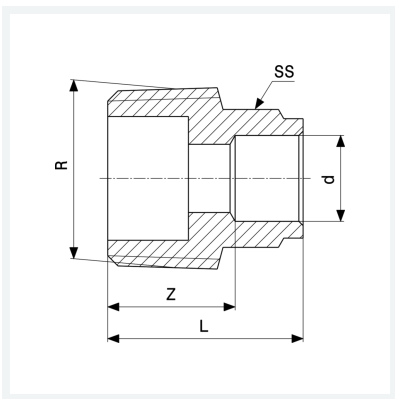

Properties

Pipe external diameter	d	22
Male thread conical	R	½
Z-dimension	Z	17 mm
Length	L	33 mm
Spanner size	SS	26 mm
Weight	45.37 g	
Volume	41.44 cm ³	
Material	gunmetal	