

Informacijski list



Prijelazni komad

- priključak za lemljenje, R-navoj

Oprema

Višestrana varijanta

Model 94243G

Artikl 100 025

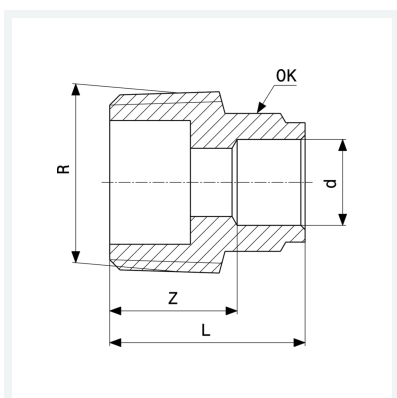

Svojstva

Vanjski promjer cijevi	d	15
Vanjski konični navoj	R	½
Z-dimenzija	Z	15 mm
Duljina	L	26 mm
Otvor ključa	OK	18 mm
Težina	23,6 g	
Volumen	24,9 cm ³	
Materijal	bronca	