

Data sheet



Adapter

- soldered connection, R-thread

Note

WRAS approved product

Model 94243G

Article 100 025

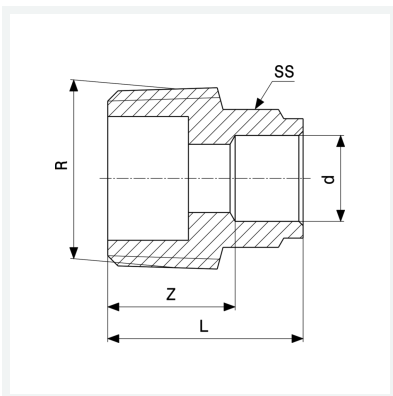

Properties

Pipe external diameter	d	15
Male thread conical	R	½
Z-dimension	Z	15 mm
Length	L	26 mm
Spanner size	SS	18 mm
Weight	23.6 g	
Volume	24.9 cm ³	
Material	gunmetal	