

# Informacijski list

**viega**



**Koljeno 90°**  
- priključak za lemljenje  
**Model 95090**

**Artikl 100 452**

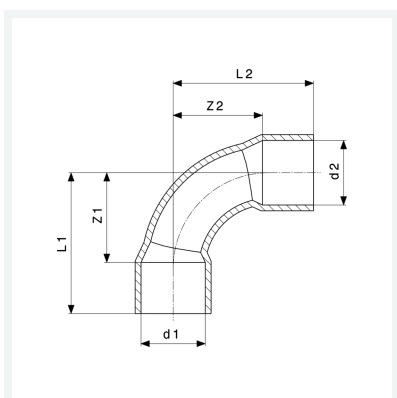

## Svojstva

Vanjski promjer cijevi 1	d1	18
Vanjski promjer cijevi 2	d2	18
Z-dimenzija 1	Z1	12 mm
Z-dimenzija 2	Z2	12 mm
Duljina 1	L1	25 mm
Duljina 2	L2	25 mm
Težina	21,4 g	
Volumen	35,52 cm <sup>3</sup>	
Materijal	bakar	